



Constant Voltage Driver

Model: XSV Series



Model	Rated Input Voltage	Input Power	Input Current	PF	Output Power Range	Output Voltage	Output Current	Efficiency (typ.)
XSV30W24	220-240VAC	≤36W	≤0.2A	≥0.95	0-30W	24V	1.25A	86%
XSV60W24		≤72W	≤0.4A		0-60W		2.5A	88%
XSV100W24		≤115W	≤0.6A		0-100W		4.17A	90%
XSV160W24		≤180W	≤0.9A		0-160W		6.67A	92%
XSV240W24		≤265W	≤1.5A		0-240W		10A	92%
XSV400W24		≤435W	≤2.3A		0-400W		16.67A	93%

* Test result @230V, 50Hz, Full Load.

1. Parameters

category	Item	Technical Norm						
Features	Output Type	Constant Voltage						
	Dimming Type	NA						
	Output Features	Isolation SELV						
	IP Grade	IP67						
	Installation	Independent						
	Insulation Class	Class I						
Input	Rated Input Voltage	220-240VAC						
	Range of AC Input Voltage	176-264VAC						
	Range of DC Input Voltage	175-280VDC (EMI not evaluated)						
	Frequency	Rate:50/60Hz, Range:47~63Hz						
	Power Factor	≥0.95, 220-240VAC, Rated Load, see graphs						
	THD	≤10%, 230VAC, Rated Load, see graphs						
	No Load Power Consumption	≤0.5W, @230VAC						
	Inrush Current	Model	IP	IP (typ.)	Duration time	240Vac/50Hz, 90-degree phase, full load, cold start-up, duration time measure from 50%l _{pk} to 50%l _{pk}		
	30W	<30A	25A	200us				
	60W	<30A	26A	220us				
	100W	<50A	45A	250us				
	160W	<60A	56A	250us				

		240W	<80A	76A	320us		
		400W	<100A	88A	430us		
	Connected quantity of 16A Breaker	30W	16pcs,16A type B / 26pcs 16A type C				
		60W	16pcs,16A type B / 26pcs 16A type C				
		100W	10pcs,16A type B / 16pcs 16A type C				
		160W	8pcs,16A type B / 13pcs 16A type C				
		240W	6pcs,16A type B / 8pcs 16A type C				
400W	4pcs,16A type B / 5pcs 16A type C						
Output	Output Voltage	24VDC±3%					
	Rated Load Range	30W	12-30W				
		60W	24-60W				
		100W	30-100W				
		160W	48-160W				
		240W	72-240W				
		400W	120-400W				
	Output Voltage Ripple	<240mV _{PK-PK} (0.5%)					
	Line Regulation	±1%					
	Load Regulation	±2%					
	Overshoot	<105%V _o (<110%V _o , only for 30W)					
	Start-up Time	<0.5S (220-240VAC)					
	Efficiency	30W	≥84%	86% typ.	230VAC, Rated Load, at output terminals, see graphs		
		60W	≥86%	88% typ.			
100W		≥90%	92% typ.				
160W		≥90%	92% typ.				
240W		≥90%	92% typ.				
400W		≥91%	93% typ.				
Protection	Short Circuit Protection	Auto Recovery					
	Over Current Protection	120%-200%I _o , Auto Recovery					
	Over Voltage Protection	120%-150%V _o , Auto Recovery					
	Over Temperature Protection	90<T _c <110°C, Auto Recovery					
	Insulation voltage	I/P to O/P,3KV _{ac} /5mA/1min					
	Insulation resistance	>100M ohm @ 500VDC					
	Leakage current	I/P to O/P < 250μA					
Environment	Ta/Operation Temperature	-25....+50°C					
	Ts/Storage Temperature	-40....+85°C					
	Tc/Enclosure Temperature For Safety	30W/60W/100W	75°C				
		160W	85°C				
		240W/400W	90°C				
	Humidity	5%....85%RH					
Atmosphere	86-108KPa						
Standards	Certification	CE					
	Safety Standards	EN61347-1:2015, EN61347-2-13:2014/A1:2017, EN62493:2015,					

		AS61347.2.13:2018,AS/NZS 61347.1:2016 Inc A1		
	EMC Standards	EN55015:2013/A1:2015, EN61000-3-2:2014, EN61000-3-3:2013, EN61547:2009		
	Performance	EN62384		
	Surge	L-N:4KV, L/N-PE:6KV		
Others	RoHS	2011/65/EU		
	MTBF	≥250KHours, Ta=25°C (MIL-HDBK-217F)		
	Audible Noise	<25dB @ 10cm distance, 20dB background		
	Life Time(@Ta max)	30W/60W/100W/160W	≥50K Hrs @230VAC, full load, End of Life: Failure Rate<10%	
		240W/400W	≥50K Hrs @230VAC, 90%load, End of Life: Failure Rate<10%	
	Warranty	5years		
	Dimensions (L*W*H)	30W	235*30*21MM (body), 250*30*21MM (endcaps included)	
		60W	275*30*21MM (body), 290*30*21MM (endcaps included)	
		100W	305*30*21MM (body), 320*30*21MM (endcaps included)	
		160W	335*30*21MM (body), 350*30*21MM (endcaps included)	
		240W	385*30*21MM (body), 400*30*21MM (endcaps included)	
400W		385*60*22MM (body), 400*60*22MM (endcaps included)		
Wiring	Input	H05RN-F/3X1.0mm ² , Brown/Blue/(Yellow/Green)		
	Output	H05RN-F/2X1.0mm ² , Brown/Blue		
Output Cable Length	Max. 3M			

Remark:

1. All Parameters, if not specified, are measured at 230VAC/50Hz and 25°C ambient temperature.
2. LED Driver is a component of the luminaires, Luminaires and wire layout will affect the EMC, please check the EMC with end products again.
3. Output ripple should be measured at the output end which has with 0.1uF/50V ceramic capacitance and 47uF/50V Aluminum capacitance connected in parallel. Measured using oscilloscope with bandwidth limited to 20MHz.

2. Graph

PF VS LOAD Curve

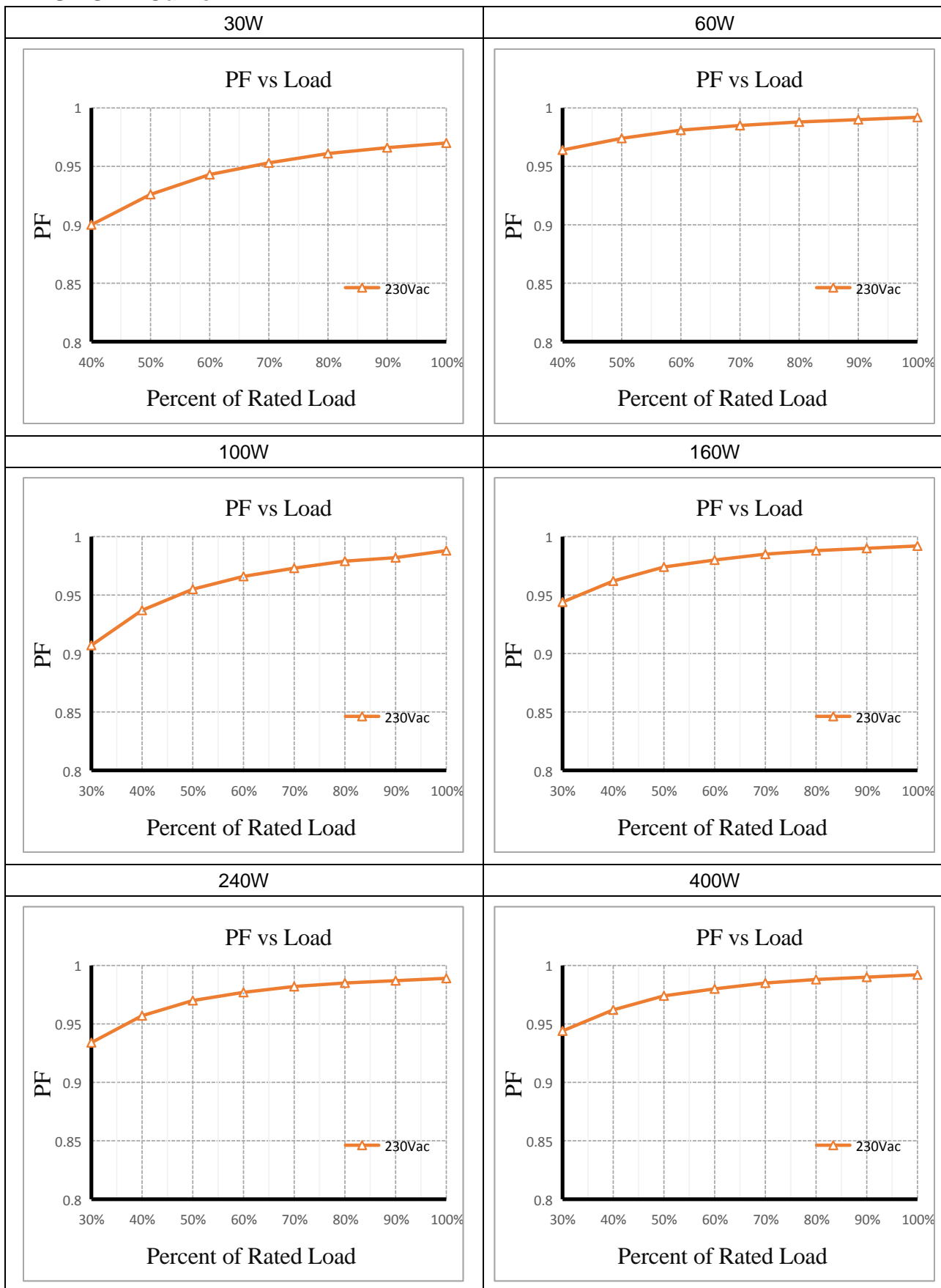

THD VS LOAD Curve

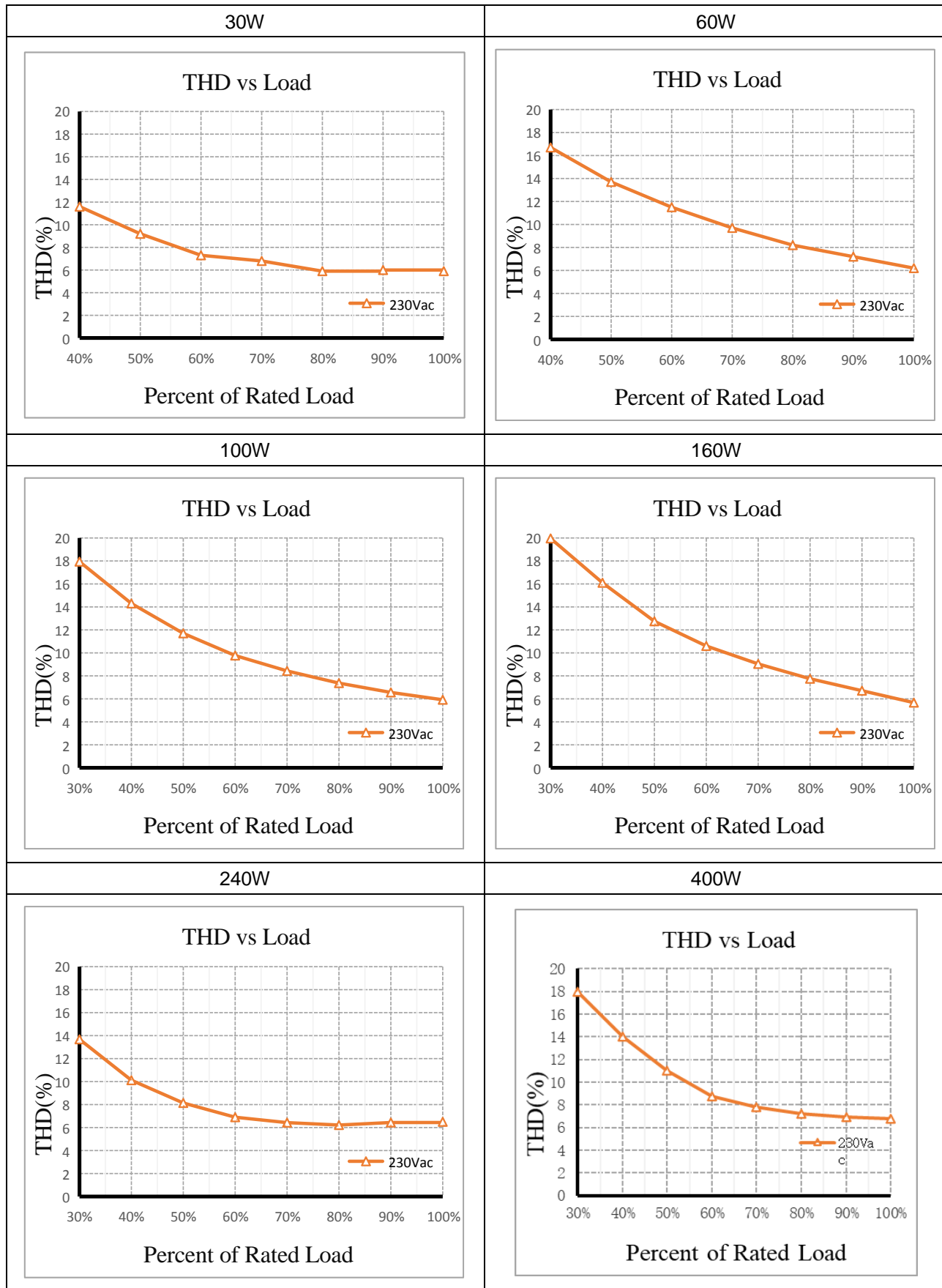

Efficiency VS LOAD Curve

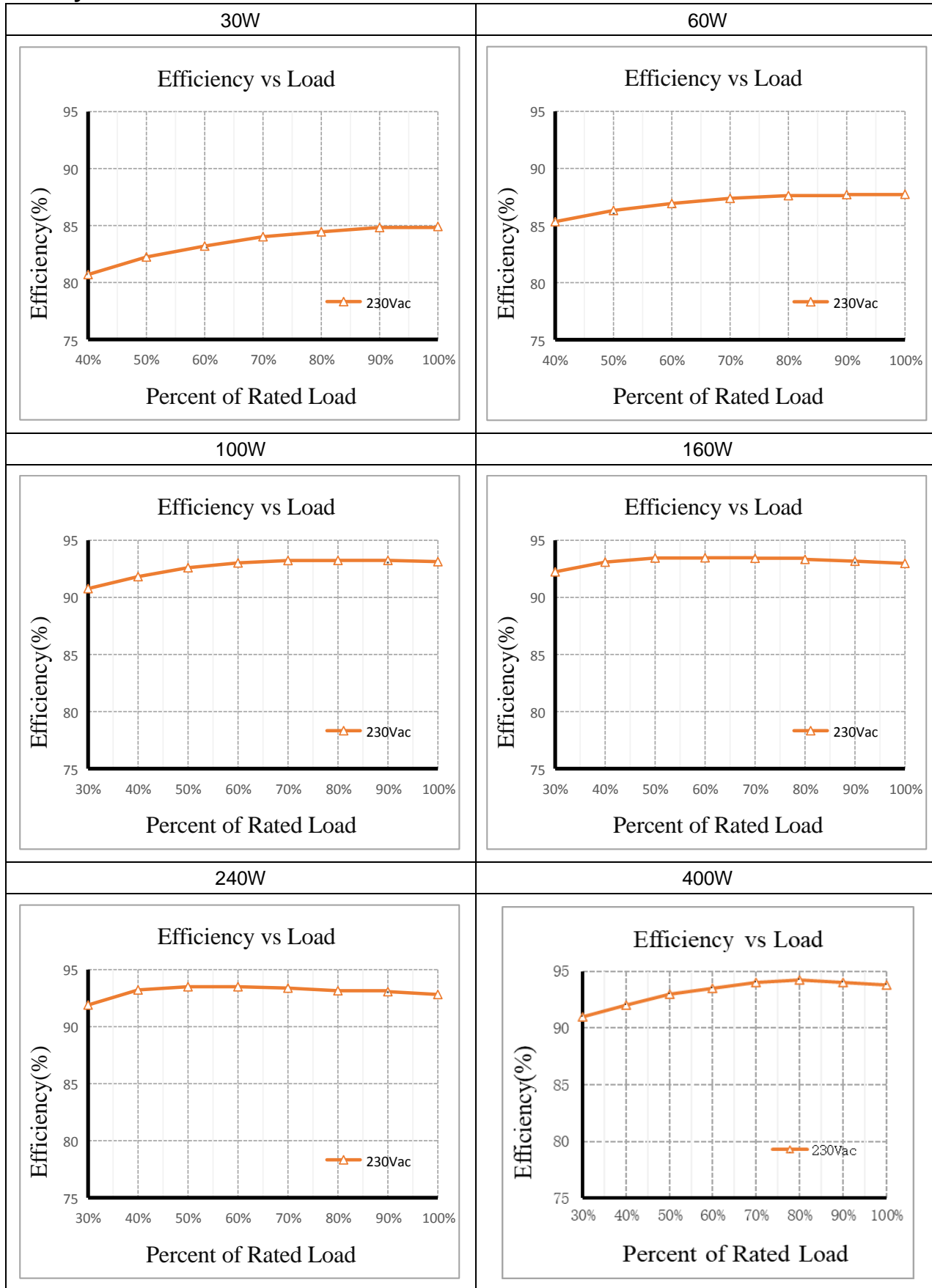

3. Label

INPUT ○ L (Brown) ○ N (Blue) ⊕ (Yellow-green)	KGP KGP Electronics GmbH Hueckstraße 19 DE-58511 Lüdenscheid	XSV30W24 LED Driver Constant Voltage Type For LED modules only	Input: 220-240V~, 50/60Hz, 0.2A, $\lambda > 0.95$	(Blue) (Brown) + OUTPUT
			Output: 24V- 0-1.25A Max.30W	
			• to: Ta: -25 ~ +50°C Tc: 75°C SELV CE ENEC IP67	

INPUT ○ L (Brown) ○ N (Blue) ⊕ (Yellow-green)	KGP KGP Electronics GmbH Hueckstraße 19 DE-58511 Lüdenscheid	XSV50W24 LED Driver Constant Voltage Type For LED modules only	Input: 220-240V~, 50/60Hz, 0.4A, $\lambda > 0.95$	(Blue) (Brown) + OUTPUT
			Output: 24V- 0-2.5A Max.60W	
			• to: Ta: -25 ~ +50°C Tc: 75°C SELV CE ENEC IP67	

INPUT ○ L (Brown) ○ N (Blue) ⊕ (Yellow-green)	KGP KGP Electronics GmbH Hueckstraße 19 DE-58511 Lüdenscheid	XSV100W24 LED Driver Constant Voltage Type For LED modules only	Input: 220-240V~, 50/60Hz, 0.6A, $\lambda > 0.95$	(Blue) (Brown) + OUTPUT
			Output: 24V- 0-4.17A Max.100W	
			• to: Ta: -25 ~ +50°C Tc: 75°C SELV CE ENEC IP67	

INPUT ○ L (Brown) ○ N (Blue) ⊕ (Yellow-green)	KGP KGP Electronics GmbH Hueckstraße 19 DE-58511 Lüdenscheid	XSV105W24 LED Driver Constant Voltage Type For LED modules only	Input: 220-240V~, 50/60Hz, 0.9A, $\lambda > 0.95$	(Blue) (Brown) + OUTPUT
			Output: 24V- 0-6.67A Max.160W	
			• to: Ta: -25 ~ +50°C Tc: 85°C SELV CE ENEC IP67	

INPUT ○ L (Brown) ○ N (Blue) ⊕ (Yellow-green)	KGP KGP Electronics GmbH Hueckstraße 19 DE-58511 Lüdenscheid	XSV240W24 LED Driver Constant Voltage Type For LED modules only	Input: 220-240V~, 50/60Hz, 1.5A, $\lambda > 0.95$	(Blue) (Brown) + OUTPUT
			Output: 24V- 0-10A Max.240W	
			• to: Ta: -25 ~ +50°C Tc: 90°C SELV CE ENEC IP67	

INPUT ○ L (Brown) ○ N (Blue) ⊕ (Yellow-green)	KGP KGP Electronics GmbH Hueckstraße 19 DE-58511 Lüdenscheid	XSV400W24 Dimmable LED Driver Constant Voltage Type For LED modules only	Input: 220-240V~, 50/60Hz, 2.3A, $\lambda > 0.95$	(Blue) (Brown) + OUTPUT (Blue) (Brown) + OUTPUT
			Output: 24V- 0-16.67A Max.400W	
			• to: Ta: -25 ~ +50°C Tc: 90°C SELV CE ENEC IP67	

4. Dimension (Unit: mm) XSV30W24

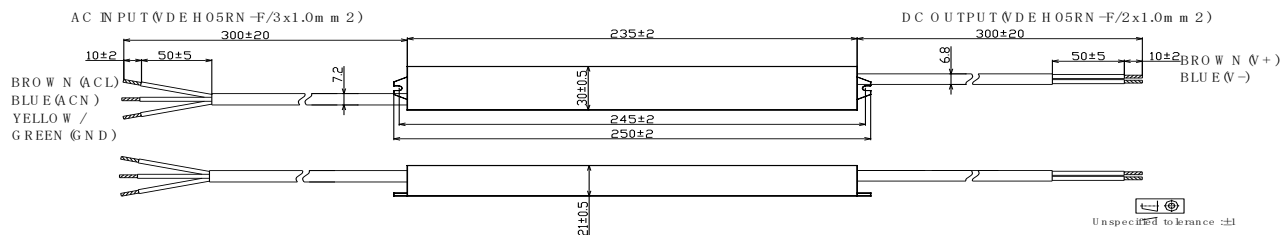

XSV60W24

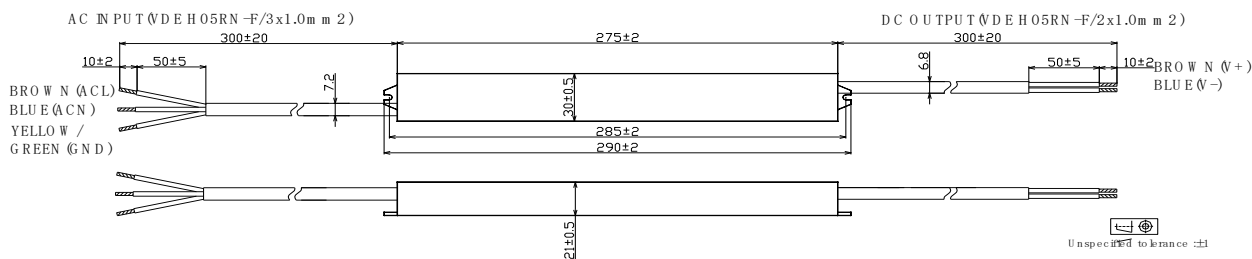

XSV100W24

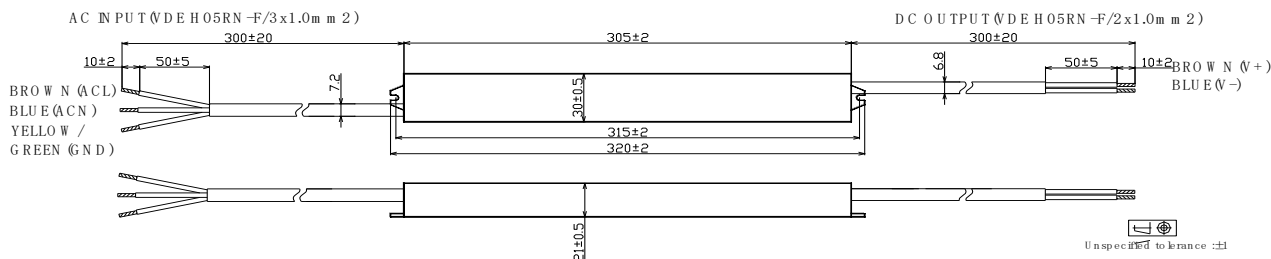

XSV160W24

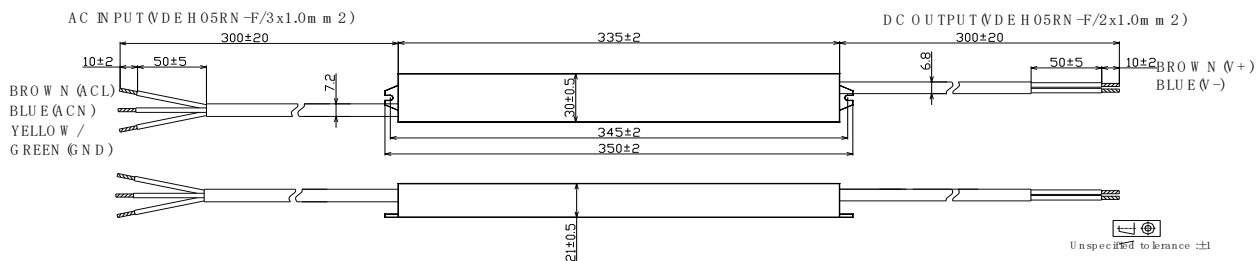

XSV240W24

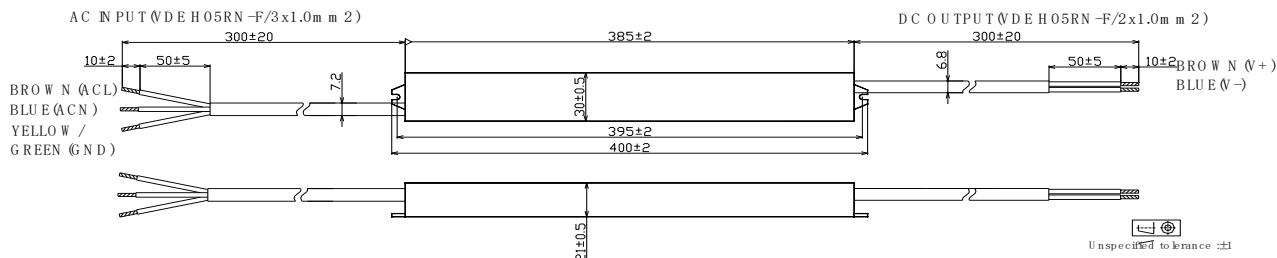

XSV400W24

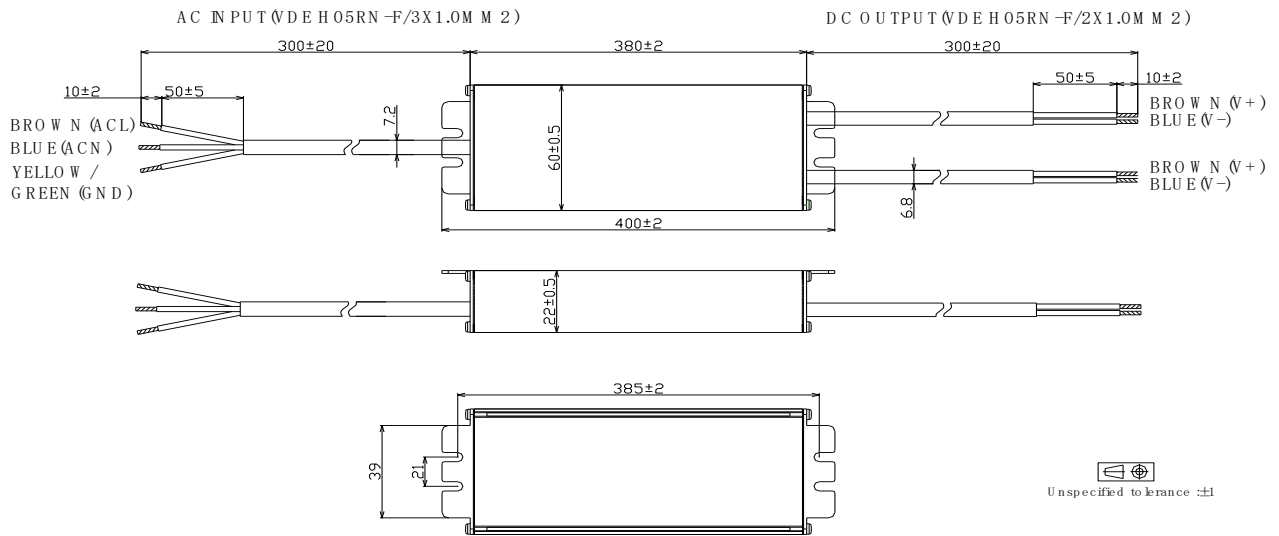

Remark: Two output cables are in parallel inside the drive, and the current of each cable does not exceed 10A.



Constant Voltage LED Driver

Packing information

Model	Carton L*W*H(cm)	Pcs/ Carton	Net weight/ Pcs(g)	Net weight/ Carton(kg)	Gross weight/ Carton(kg)
XSV30W24	34*29*20	30	340	9.45	11.0
XSV60W24	34*29*20	30	390	11.25	12.8
XSV100W24	39*29*20	30	420	12	13.7
XSV160W24	39*29*20	30	470	13.5	15.2
XSV240W24	44*29*14	20	530	10.2	11.5
XSV400W24	44*29*14	12	1050	12.24	13.2